

S.79A



COPRITESTA IN GOMMA 30X65
Colore: nero
Cod. PL-080



COPRITESTA IN GOMMA 30X80
Colore: nero
Cod. PL-081



PIEDE SNODO PICCOLO 30X65
Cod. PSP



PIEDE SNODO GRANDE 30X80
Cod. PSG



RUOTA SCORRIMURO Ø 50
Cod. FE-022



TELAIO ROMPIRATTA FISSO
Cod. ROTRAT



TELAIO ROMPIRATTA REGOLABILE
Cod. ROTRTE



BILANCIERE PER SCALE CON FUNE
Cod. FE-036



LIVELLATORE A VITE C/PIEDE SNODATO PER SCALA SERIE 79/A
Cod. LIV-79A



RAMPONE PER SCALA SERIE 79/A
Cod. FE-025



TERMINALI FUSIONE 1D
Montanti: 30x65 per elemento base DX
Cod. FU-001A



TERMINALI FUSIONE 1S
Montanti: 30x65 per elemento base SX
Cod. FU-001B



TERMINALI FUSIONE 2D
Montanti: 30x65 per elemento centrale DX
Cod. FU-002A



TERMINALI FUSIONE 2S
Montanti: 30x65 per elemento centrale SX
Cod. FU-002B



TERMINALI FUSIONE 3D
Montanti: 30x65 per secondo elemento DX
Cod. FU-003A

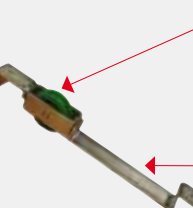

TERMINALI FUSIONE 3S
Montanti: 30x65 per secondo elemento SX
Cod. FU-003B



TERMINALI FUSIONE 11D
Montanti: 30x80 per elemento base DX
Cod. FU-004A



TERMINALI FUSIONE 11S
Montanti: 30x80 per elemento base SX
Cod. FU-004B

TERMINALI FUSIONE 12D
Montanti: 30x80 per elemento centrale DX
Cod. FU-005A

TERMINALI FUSIONE 12S
Montanti: 30x80 per elemento centrale SX
Cod. FU-005B

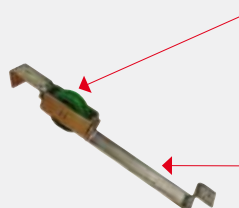

CARRUCOLA PER SCALE CON FUNE
Montanti: 30x80 per elemento centrale
Cod. FE-066

RINFORZO PER SCALE CON FUNE PORTA CARRUCOLA
Cod. FE-023

ROLLER



PIEDE MASCHIO BASE 25x90 mm
Cod. PL329/A



PIEDE MASCHIO SECONDA / TERZA RAMPA 25x90 mm
Cod. PL328/A

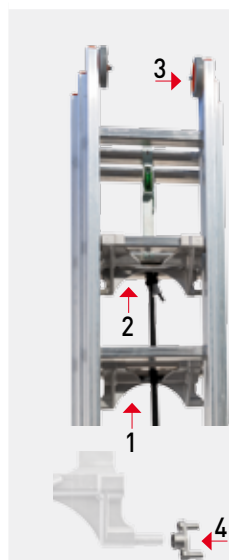

1- BILANCIERE DI BASE
Cod. FU-085/A

2- BILANCIERE SECONDO ELEMENTO
Cod. FU-086/A

3- RUOTA SCORRIMURO
Diametro: 100
Cod. PL-028/A

SUPPORTO PER LA ROTAZIONE DEL
BILANCIERE
Cod. FU-083

STRUMENTA/PROFESSIONAL 1



CERNIERA COMPLETA FUSIONE
ALLUMINIO
Cod. FU-074



GANCIO PORTA ATTREZZI "STRUMENTA -
PROFESSIONAL 1"
Cod. PL-047



MANIGLIA "STRUMENTA" IN GOMMA
Colore: verde
Cod. PL-046



PIEDE DOPPIA INCLINAZIONE "STRUMENTA -
PROFESSIONAL 1"
Dimensioni: 24 x 60. Colore: verde
Cod. PL-012/V



CINGHIA DI SICUREZZA
H 20 mm. L. 570 mm. (P1 6-7). Colore: blu
Cod. NA-019

CINGHIA DI SICUREZZA
H 20 mm. L. 870 mm. (P1 8-9-10-12).
Colore: blu
Cod. NA-020

CINGHIA DI SICUREZZA
H 30 mm. L. 540 mm. (P1V 6-7).
Colore: verde
Cod. NA-021

CINGHIA DI SICUREZZA
H 30 mm. L. 840 mm. P1V 8-9-10-12).
Colore: verde
Cod. NA-022



TASSELLO C/FORO PER FISSAGGIO CINGHIA
(SOLO PER VETRORESINA)
Colore: rosso
Cod. PL-321

LINGUETTA D'INCONTRO TRA MONTANTI
Colore: rosso
Cod. PL-100

CONICA



PIEDE SNODO PICCOLO 55x120 mm
Cod. PSP



PUNTALE FISSO
Cod. PU-P65



PUNTALE SNODATO
Cod. PU-P65/S



PIEDE SNODO OVALE GOMMATO 16x11 mm
Cod. PS-0



PIEDE ALTO DI SERIE
Colore: verde
Cod. PL-073

AGRI

TIRANTE ASTA RETRO
Lunghezza: 600 mm (AG250/AG300)
Cod. PL-112

TIRANTE ASTA RETRO
Lunghezza: 840 mm (AG350/AG400)
Cod. PL-112/1

TIRANTE ASTA RETRO
Lunghezza: 1195 mm (AG450)
Cod. PL-112/2

TIRANTE ASTA RETRO
Lunghezza: 1595 mm (AG500)
Cod. PL-112/3

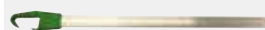

GANCIO PER TIRANTE ASTA RETRO
Cod. PL-112/G



COPRITESTA PER PIEDE SCALA
(LATO SALITA)
Dimensioni: 30 x 65. Colore: verde
Cod. PL-084



CALZARE VERDE ALTO (ASTA RETRO)
Cod. PL-061



CERNIERA IN ACCIAIO PER ASTA RETRO
Cod. FE-012



CAVALLOTTO FERMA ASTA RETRO A MOLLA
Cod. PL-113

SOLO ASTA RETRO C/TAPPO DI BASE (AG200)
Cod. AG-RE/20

SOLO ASTA RETRO C/TAPPO DI BASE (AG250)
Cod. AG-RE/25

SOLO ASTA RETRO C/TAPPO DI BASE (AG300)
Cod. AG-RE/30

SOLO ASTA RETRO C/TAPPO DI BASE (AG350)
Cod. AG-RE/35

SOLO ASTA RETRO C/TAPPO DI BASE (AG400)
Cod. AG-RE/40

SOLO ASTA RETRO C/TAPPO DI BASE (AG450)
Cod. AG-RE/45

SOLO ASTA RETRO C/TAPPO DI BASE (AG500)
Cod. AG-RE/50

SUPER PRIMA / VETROPRIMA



CERNIERA FUSIONE PER ELEMENTO BASE 65
Dimensioni: 25 x 65 P65 DX
Cod. FU-014

CERNIERA FUSIONE PER ELEMENTO BASE 65
Dimensioni: 25 x 65 P65 SX
Cod. FU-015



CERNIERA FUSIONE PER ELEMENTO BASE 80
Dimensioni: 25 x 80 P80 DX
Cod. FU-012

CERNIERA FUSIONE PER ELEMENTO BASE 80
Dimensioni: 25 x 80 P80 SX
Cod. FU-013



CERNIERA FUSIONE PER ELEMENTO BASE 90
Dimensioni: 25 x 90 P90 DX
Cod. FU-017

CERNIERA FUSIONE PER ELEMENTO BASE 90
Dimensioni: 25 x 90 P90 SX
Cod. FU-018



COPPIA DI STAFFE DI SCORRIMENTO
Dimensioni: 25 x 65. In acciaio plastificato
Cod. PL-023

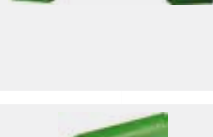

COPPIA DI STAFFE DI SCORRIMENTO
Dimensioni: 25 x 80. In acciaio plastificato
Cod. PL-024



COPPIA DI STAFFE DI SCORRIMENTO
Dimensioni: 25 x 90. In acciaio plastificato
Cod. PL-025



TAMPONE IN GOMMA LATERALE
PER BARRA TELESCOPICA
Cod. PL-021



VOLANTINO PER BARRA ANTICHIUSURA
AD ESPANSIONE (COMPLETO)
Cod. PL-030



VOLANTINO PER BARRA STABILIZZATRICE
"PRIMA"
Colore: verde
Cod. PL-031



COPRITESTA IN GOMMA "PRIMA" 25X65
Colore: verde
Cod. PL-037



COPRITESTA IN GOMMA "PRIMA" 25X80
Colore: verde
Cod. PL-039



COPRITESTA IN GOMMA "PRIMA"
Dimensioni: 25 x 90. Colore: verde
Cod. PL-040

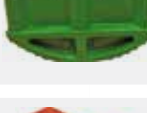

ANTISFILO LATERALE ALTO PER 2° RAMPA
Cod. PL-027



ANTISFILO LATERALE BASSO PER 3° RAMPA
Cod. PL-027/B



GANCIO ANTISFILO PER GRADINO
Solo parte in nylon rosso
Cod. PL-026



GRUPPO ANTISFILO COMPLETO PER GRADINO
Sup. metal. + gancio + molla
Cod. GA-ROM





RAMPONE PER AGGANCIAMENTO SUL GRADINO
In acciaio
Cod. FE-038



RUOTA SCORRIMURO
Diametro: 100
Cod. PL-028



CALZARE FEMMINA "PRIMA"
Dimensioni: 25 x 65. Colore: verde
Cod. PL-042



CALZARE FEMMINA "PRIMA"
Dimensioni: 25 x 80. Colore: verde
Cod. PL-041



COPPIA STAFFE DI SCORRIMENTO "VETROPRIMA"
Dimensioni: 25 x 65
Cod. PL-043

COPPIA STAFFE DI SCORRIMENTO "VETROPRIMA"
Dimensioni: 25 x 90
Cod. PL-045



BRACCIALE DI SCORRIMENTO PER FUNI
Dimensioni: 25 x 80
Cod. PL-057

BRACCIALE DI SCORRIMENTO PER FUNI
Dimensioni: 25 x 90
Cod. PL-058



BARRA STABILIZZATRICE TELESCOPICA "PRIMA"
Codici:
BA-TEL65 (25x65)
BA-TEL80 (25x80)
BA-TEL90 (25x90)

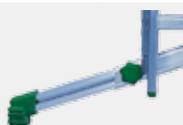

ELEMENTO SCORREVOLE DESTRO
Cod. BA-TEL/SCDX

ELEMENTO SCORREVOLE SINISTRO
Cod. BA-TEL/SCSX

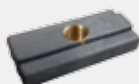

PIASTRINA SCORREVOLE INTERNA STAMPATA PER BARRA TELESCOPICA
Cod. PIASTRINA -01



BARRE ANTI CHIUSURA "PRIMA"
(SPECIFICARE IL MODELLO)

Codici:
BA-P600 (P210-P240-P260)
BA-P840 (P290-P320)
BA-P1195 (P350-P380-P420-P450)

DAMA / GENIA



BARRA STABILIZZATRICE "GENIA" 30x65mm

Cod. BA-F69A (G200-2/3) 69cm

Cod. BA-F77A (G250-2/3) 77cm

Cod. BA-F79A (G260-2/3) 79cm

Cod. BA-F93A (G300-320-2/3) 93cm

Cod. BA-F114A (G350-380-2/3) 114cm

SPECIFICA:

GENIA=
Plastiche Arancio

DAMA=
Plastiche verdi

BARRA STABILIZZATRICE "DAMA" 30x65mm

Cod. BA-F77 (D200-2/3) 77cm

Cod. BA-F93 (D260-290-2/3/4) 93cm

Cod. BA-F114 (D350-380-2/3/4) 114cm



BARRA ANTICHIUSURA "DAMA"
(D260 = 3/4 rampe)

Cod. BA-D750

BARRA ANTICHIUSURA "DAMA"
(D290 = 3/4 rampe)

Cod. BA-D970

BARRA ANTICHIUSURA "DAMA"
(D350/D380 = 2/3/4 rampe)
Cod. BA-D1365



PIEDE GOMMA LATERALE PER BARRA STABILIZZATRICE "DAMA" - "GENIA"
Cod. PL-128

SPECIFICARE:
DAMA= VERDE
GENIA= ARANCIO



COPRITESTA MASCHIO IN GOMMA "GENIA"
Dimensioni: 25 x 65. Colore: arancio
Cod. PL-037/A



COPRITESTA MASCHIO LEGGERO IN GOMMA "GENIA"
Dimensioni: 25 x 90. Colore: arancio
Cod. PL-040/A



CALZARE FEMMINA "GENIA"
Dimensioni: 25 x 65. Colore: arancio
Cod. PL-042/A



COPRITESTA SUPERIORE PESANTE "GENIA" A TRE RAMPE
Dimensioni: 25 x 90. Colore: arancio
Cod. PL-324/A



FUSIONE BASE "DAMA" - "GENIA"
Dimensioni: 25 x 65 DX
Cod. FU-050

FUSIONE BASE "DAMA" - "GENIA"
Dimensioni: 25 x 65 SX
Cod. FU-051



FUSIONE 2° ELEMENTO C/BRAC. + PERNO "DAMA" - "GENIA"
 Dimensioni: 25 x 65 DX
Cod. FU-052

FUSIONE 2° ELEMENTO C/BRAC. + PERNO "DAMA" - "GENIA"
 Dimensioni: 25 x 65 SX
Cod. FU-053



FUSIONE 3° ELEMENTO PORTARUOTA "DAMA" - "GENIA"
 Dimensioni: 25 x 65 DX
Cod. FU-054

FUSIONE 3° ELEMENTO PORTARUOTA "DAMA" - "GENIA"
 Dimensioni: 25 x 65 SX
Cod. FU-055



FUSIONE 2° ELEMENTO S/BRAC. + PERNO "DAMA" - "GENIA"
 Dimensioni: 25 x 65 DX
Cod. FU-056

FUSIONE 2° ELEMENTO S/BRAC. + PERNO "DAMA" - "GENIA"
 Dimensioni: 25 x 65 SX
Cod. FU-057



FUSIONE BASE "DAMA" - "GENIA"
 Dimensioni: 25 x 90 DX "DAMA" - "GENIA"
Cod. FU-060

FUSIONE BASE "DAMA" - "GENIA"
 Dimensioni: 25 x 90 SX "DAMA" - "GENIA"
Cod. FU-061



FUSIONE 2° ELEMENTO C/BRAC. + PERNO "DAMA" - "GENIA"
 Dimensioni: 25 x 90 DX
Cod. FU-062

FUSIONE 2° ELEMENTO C/BRAC. + PERNO "DAMA" - "GENIA"
 Dimensioni: 25 x 90 SX
Cod. FU-063



FUSIONE 3° ELEMENTO PORTARUOTA "DAMA" - "GENIA"
 Dimensioni: 25 x 90 DX
Cod. FU-064

FUSIONE 3° ELEMENTO PORTARUOTA "DAMA" - "GENIA"
 Dimensioni: 25 x 90 SX
Cod. FU-065



FUSIONE 2° ELEMENTO S/BRAC. + PERNO "DAMA" - "GENIA"
 Dimensioni: 25 x 90 DX
Cod. FU-066

FUSIONE 2° ELEMENTO S/BRAC. + PERNO "DAMA" - "GENIA"
 Dimensioni: 25 x 90 SX
Cod. FU-067



CINGHIA DI SICUREZZA "DAMA" Verde
 H: 30 mm. L 2270 mm. (200 = 2 rampe)
 Colore: verde
Cod. NA-015

CINGHIA DI SICUREZZA "DAMA" Verde
 H: 30 mm. L 2730 mm. (260 = 2 rampe)
 Colore: verde
Cod. NA-016

CINGHIA DI SICUREZZA "DAMA" Verde
 H: 30 mm. L 3060 mm. (290 = 2 rampe)
 Colore: verde
Cod. NA-017

CINGHIA DI SICUREZZA "GENIA" Arancio
 H: 30 mm. L 1130 mm. (250 = 2/3 rampe)
 Colore: arancio
Cod. NA-032



CINGHIA DI SICUREZZA "GENIA" Arancio
 H: 30 mm. L 1330 mm. (300 = 2/3 rampe)
 Colore: arancio
Cod. NA-033

CINGHIA DI SICUREZZA "GENIA" Arancio
 H: 30 mm. L 1720 mm. (350 = 2/3 rampe)
 Colore: arancio
Cod. NA-035

CINGHIA DI SICUREZZA "GENIA" Arancio
 H: 30 mm. L 1880 mm. (380 = 2/3 rampe)
 Colore: arancio
Cod. NA-036

STILO TRASFORMABILE

BARRA STABILIZZATRICE STILO
 Modelli: 2x6/3x6/2x7/3x7/2x8/3x8

Cod. BA-ST76 (76cm)

Modelli: 2x9/3x9/2x10/3x10

Cod. BA-ST86 (86cm)

Modelli: 2x11/3x11/2x12/3x12

Cod. BA-ST96 (96cm)



CERNIERA ACCIAIO PER BASE

Modelli: 2x6/3x6/2x7/3x7/2x8/3x8/2x9

Cod. FE-200DX (destra)

Cod. FE-200SX (sinistra)

Modelli: 2x10

Cod. FE-206DX (destra)

Cod. FE-206SX (sinistra)

Modelli: 3x9

Cod. FE-202DX (destra)

Cod. FE-202SX (sinistra)

Modelli: 3x10

Cod. FE-204DX (destra)

Cod. FE-204SX (sinistra)

Modelli: 2X11/3x11/3x12

Cod. FE-212DX (destra)

Cod. FE-212SX (sinistra)



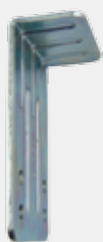

CERNIERA ACCIAIO PER ELEMENTO CENTRALE
 Modelli: 3x6/3x7/3x8/3x9
Cod. FE-208
 Modelli: 3x10
Cod. FE-209
 Modelli: 3x11/3x12
Cod. FE-214

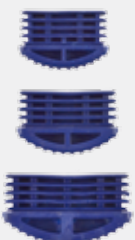

COPRITESTA 24X60
Cod. PL-075/BLU
COPRITESTA 25X65
Cod. PL-352
COPRITESTA 25X80
Cod. PL-353



COPRITESTA LATERALE 24X50 PER BARRA STABILIZZATRICE
Cod. PL-345



TASSELLO ROSSO ANTISFILO
Cod. PL-355



CINGHIA ROSSA ANTI DIVARICAMENTO 30mm
 Lunghezza: cm | 80 | 99 | 118 | 138 | 141 | 156 | 182
 gradini n. | 6 | 7 | 8 | 9 | 10 | 11 | 12
Cod. NA- | 065 | 060 | 061 | 062 | 073 | 063 | 064
 (Specificare)



RAMPONE DI AGGANCIAMENTO AL GRADINO
 (completo di sicurezza anti sfilo)
Cod. SLGA

HOBBY SEI / HOBBY DUE



BARRA STABILIZZATRICE "HOBBY SEI - HOBBY DUE"
 Dimensioni: 77 cm
Cod. BA-F77

QUADRA / DUPLA



VASCHETTA PORTAOGGETTI Q50
 Colori: nero, verde, arancio (specificare)
Cod. PL-006
VASCHETTA PORTAOGGETTI Q60
 Colori: nero
Cod. PL-009



PEDANA "QUADRA" IN ALLUMINIO FUSO
Cod. FU-009NT



PIEDE ANTERIORE "QUADRA"
 Colori: nero, verde, arancio (specificare)
 Dimensioni: 24 x 50 doppia inclinazione
Cod. PL-014
PIEDE POSTERIORE "QUADRA"
 Dimensioni: 24 x 50 mono inclinazione
Cod. PL-015
PIEDE "QUADRA" ANTERIORE/POSTERIORE
 Dimensioni: 24 x 60 nero
Cod. PL-012



KIT 2 BRONZINE/1 BIELLA/2 FRIZIONI
 Colori: nero, verde, arancio (specificare)
Cod. PL-001



CERNIERA "QUADRA"
 Dimensioni: 24 x 50
Cod. FU-010
CERNIERA "QUADRA"
 Dimensioni: 24 x 60
Cod. FU-011

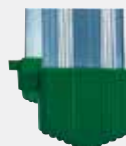

PIEDE DOPPIA INCLINAZIONE CON DISTANZIALE "DUPLA"
 Colore: verde
Cod. PL-051V



LINGUETTA D'INCONTRO TRA I MONTANTI
 Colore: verde
Cod. PL-054V



CERNIERA IN ALLUMINIO PER SCALA E SGABELLO "DUPLA"
Cod. FU-078



COMPASSO ANTICHIUSURA SGABELLO "DUPLA"
Cod. FE-098



TAPPO CON FORO SGABELLO "DUPLA" (FISSAGGIO COMPASSO)
 Dimensioni: 24 x 24
Cod. PL-130



MONOBLOCCO
 Due cerniere con pianetti
Cod. DU-CEPI



CINGHIA DI SICUREZZA "QUADRA"
H: 20. L: 755 mm (5/6/7/8 gradini). Colore: blu
Cod. NA-050

CINGHIA DI SICUREZZA "QUADRA"
H: 20. L: 1090 mm (9/10/11/12/13 gradini). Colore: blu
Cod. NA-051



CINGHIA DI SICUREZZA "DUPLA"
H: 30. L: 640 mm (5/6 gradini). Colore: verde
Cod. NA-008

CINGHIA DI SICUREZZA "DUPLA"
H: 30. L: 820 mm (7/8/9 gradini). Colore: verde
Cod. NA-009

CINGHIA DI SICUREZZA "DUPLA"
H: 30. L: 1140 mm (10/12 grad). Colore: verde
Cod. NA-010



SUPPORTO PIEGHEVOLE PER MANCORRENTE IN ALLUMINIO "QUADRA"
Cod. FU-109



GANCIO DI SICUREZZA INTERCAMBIABILE PER PEDANA "QUADRA" + spina elastica
Colore: rosso
Cod. PL-315

DIVA



TESTATA CON RUOTE "DIVA"
Cod. DI-TESTATA



LIVELLATORE A VITE "DIVA"
Cod. AMLV



PARAPETTO "DIVA" (specificare modello)
Cod. DIPAR-90

PARAPETTO "DIVA" (specificare modello)
Cod. DIPAR-120



CROCERA A 4 VIE PER PARAPETTO
Cod. FU-103



SUPPORTO CON ASOLA PER MANCORRENTE
Cod. FU-100



BICCHIERE PORTA MANCORRENTE
Cod. FU-101



BARRA PER "DIVA" 90 DA 2 A 3 GRADINI
Cod. BARRA2-3/90

BARRA PER "DIVA" 90 DA 4 A 8 GRADINI
Cod. BARRA4-8/90

BARRA PER "DIVA" 120 DA 2 A 3 GRADINI
Cod. BARRA2-3/120

BARRA PER "DIVA" 120 4 A 8 GRADINI
Cod. BARRA4-8/120

ALFA



CERNIERA
Cod. FE-071



MANIGLIA
Cod. PL-095A

MAYORÀ



1- MANCORRENTE Ø 25mm
Cod. MY-MAN5/1020
Cod. MY-MAN6/1270
Cod. MY-MAN7/1520
Cod. MY-MAN8/1770
Cod. MY-MAN9/2020

2- MANOPOLA
Cod. PL-019

3- MANIGLIA COMPLETA (tubo+articolazione+manopola)
Cod. MI-MGL

4- RUOTA
Cod. RU-035

5- SUPPORTO RUOTA ACCIAIO
Cod. FE-244

6- TIRANTE A COMPASSO PER MAYORÀ
Cod. MY-COMP5/578
Cod. MY-COMP6/742
Cod. MY-COMP7/916
Cod. MY-COMP8/1070
Cod. MY-COMP9/1200

per altri ricambi riferirsi a Tecnoscala Quadra



ARTICOLAZIONE PER MANIGLIA (2 corpi)
Cod. MY-ART

EUROBRIKO/BRIKO PLUS



PIEDE BASSO PER ELEMENTI INTERNI
Colore: verde, arancio
Cod. PL-075



PIEDE ALTO PER ELEMENTI ESTERNI
Colore: verde, arancio
Cod. PL-073



TIRANTE GRADINO "EUROBRIKO"
Cod. PL-072

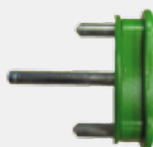

TIRANTE CERNIERA "EUROBRIKO"
Cod. PL-074



SNODO COMPLETO "EUROBRIKO"
Cod. SNODOBK



COPRISALD. GRAD. "EUROBRIKO" (VERDE)
Cod. PL-070

COPRISALD. GRAD. "BRIKO PLUS" (ARANCIO)
Cod. PL-070/A

BUSSOLA CHIUSA "EUROBRIKO" (VERDE)
Cod. PL-071

BUSSOLA CHIUSA "BRIKO PLUS" (ARANCIO)
Cod. PL-071/A

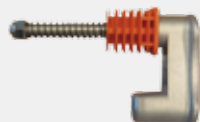

TIRANTE GRADINO IN ALLUMINIO E INOX
"EUROBRIKO PLUS"
Cod. FU-104



CERNIERA AUTOMATICA IN ACCIAIO
"EUROBRIKO PLUS"
Cod. FE-069

CINGHIA DI SICUREZZA CON MOSCHETTONE
"EUROBRIKO"

H: 25. L: 570 mm

Cod. NA-BK1

CINGHIA DI SICUREZZA CON MOSCHETTONE
"EUROBRIKO"

H: 25. L: 735 mm

Cod. NA-BK1,5/2

CINGHIA DI SICUREZZA CON MOSCHETTONE
"EUROBRIKO"

H: 25. L: 950 mm

Cod. NA-BK3/4

CINGHIA DI SICUREZZA CON MOSCHETTONE
"EUROBRIKO"

H: 25. L: 1120 mm

Cod. NA-BK5

CINGHIA DI SICUREZZA CON MOSCHETTONE
"EUROBRIKO"

H: 25. L: 1220 mm

Cod. NA-BK6



CASTIGLIA

TERMINALE GRADINO COMPLETO DI VITI

Cod. CA-TGC DX

Cod. CA-TGC SX

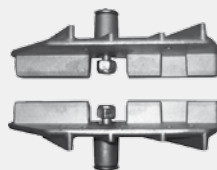

Specificare

CS4 CAVALLOTTO SINGOLO IN FUSIONE FINO
A CA6/255

Cod. FU-023



CS6 SUPPORTO IN FUSIONE PER DIAGONALE
DI RINFORZO DA CA7/250

Cod. FU-022



CS5 CAVALLOTTO DOPPIO IN FUSIONE PER
DOPPIA DIAGONALE DA CA7/250

Cod. FU-024



CS7 FUSIONE PIATTA CON FILETTO PER
FISSAGGIO MANIGLIA

Cod. FU-025





RUOTA ANTERIORE Ø 80 mm CON PERNO IN ACCIAIO + MOLLA
Cod. RU-010/P

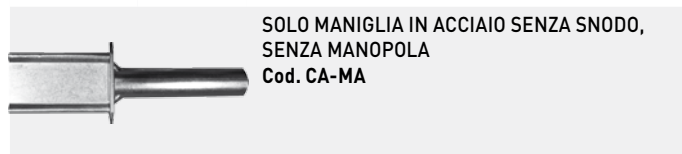

SOLO MANIGLIA IN ACCIAIO SENZA SNODO, SENZA MANOPOLA
Cod. CA-MA



RUOTA POSTERIORE Ø 125 mm COMPLETA DI CARPENTERIA E FRENO
Cod. RU-008

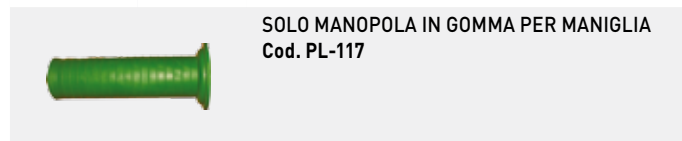

SOLO MANOPOLA IN GOMMA PER MANIGLIA
Cod. PL-117

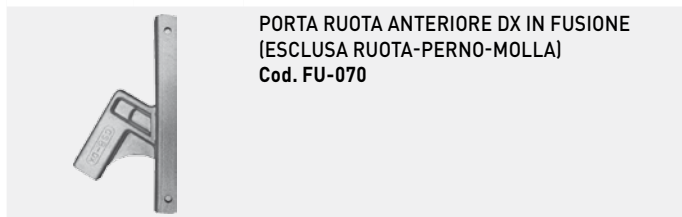

PORTA RUOTA ANTERIORE DX IN FUSIONE (ESCLUSA RUOTA-PERNO-MOLLA)
Cod. FU-070



TAPPO MASCHIO PER MANIGLIA
Dimensione: 30 x 50. Colore: verde
Cod. PL-064V

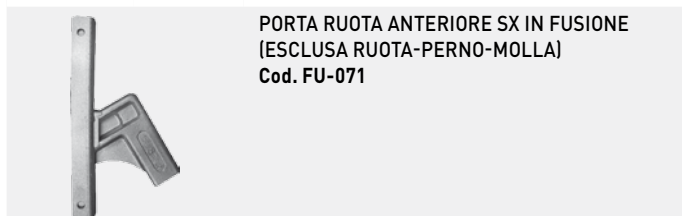

PORTA RUOTA ANTERIORE SX IN FUSIONE (ESCLUSA RUOTA-PERNO-MOLLA)
Cod. FU-071



MANIGLIONE DI SBARCO SUPERIORE "CASTIGLIA"
Cod. CA-MAS



PORTA RUOTA POSTERIORE DX IN ALLUMINIO PER RUOTA DIAMETRO 125
Cod. FU-072

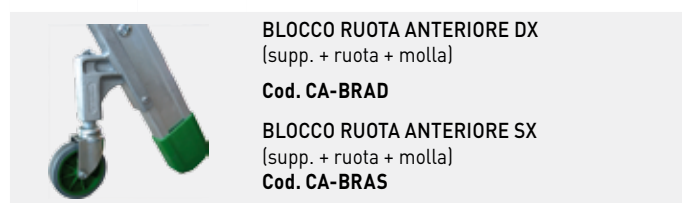

BLOCCO RUOTA ANTERIORE DX (supp. + ruota + molla)
Cod. CA-BRAD



PORTA RUOTA POSTERIORE SX IN ALLUMINIO PER RUOTA DIAMETRO 125
Cod. FU-073

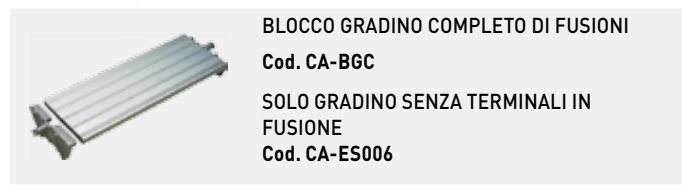

BLOCCO RUOTA ANTERIORE SX (supp. + ruota + molla)
Cod. CA-BRAS

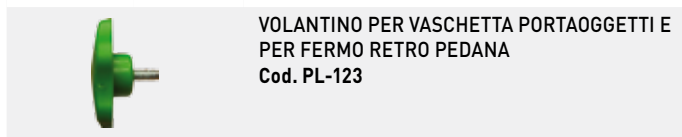

VOLANTINO PER VASCHETTA PORTAOGGETTI E PER FERMO RETRO PEDANA
Cod. PL-123

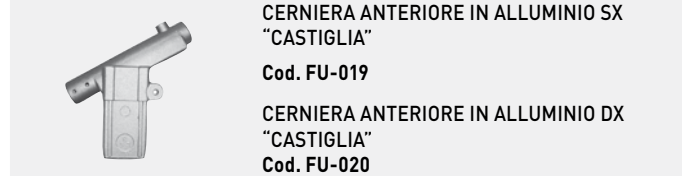

BLOCCO GRADINO COMPLETO DI FUSIONI
Cod. CA-BGC

SOLO GRADINO SENZA TERMINALI IN FUSIONE
Cod. CA-ES006

CERNIERA ANTERIORE IN ALLUMINIO SX "CASTIGLIA"
Cod. FU-019

CERNIERA ANTERIORE IN ALLUMINIO DX "CASTIGLIA"
Cod. FU-020



PORTAOGGETTI TUTTO ALLUMINIO
Cod. CA-POR

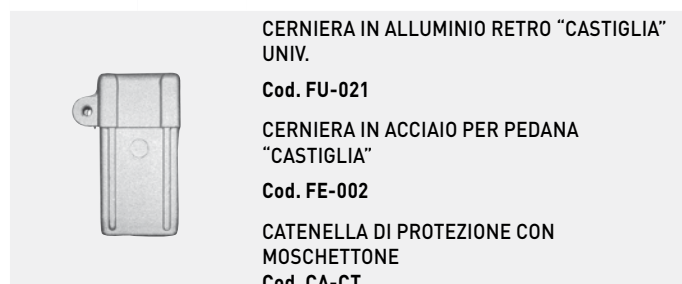

CERNIERA IN ALLUMINIO RETRO "CASTIGLIA" UNIV.
Cod. FU-021

CERNIERA IN ACCIAIO PER PEDANA "CASTIGLIA"
Cod. FE-002

CATENELLA DI PROTEZIONE CON MOSCHETTONE
Cod. CA-CT

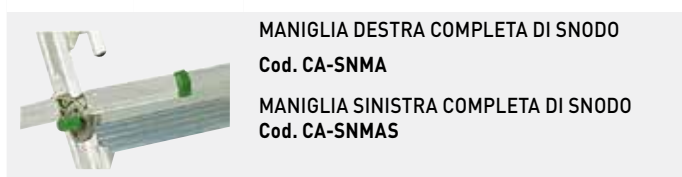

MANIGLIA DESTRA COMPLETA DI SNODO
Cod. CA-SNMA

MANIGLIA SINISTRA COMPLETA DI SNODO
Cod. CA-SNMA S

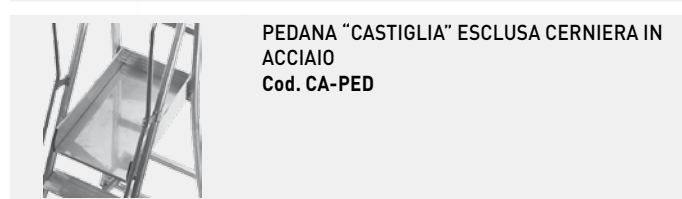

PEDANA "CASTIGLIA" ESCLUSA CERNIERA IN ACCIAIO
Cod. CA-PED

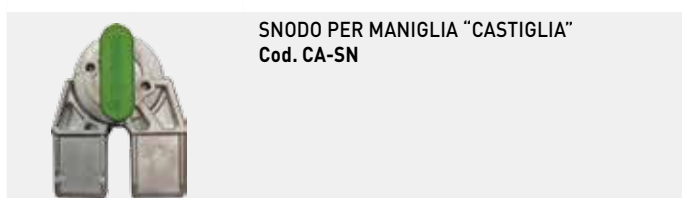

SNODO PER MANIGLIA "CASTIGLIA"
Cod. CA-SN



MOLLETTONE ACCIAIO SOTTO PEDANA
Cod. FE-002



SOLO RUOTA POSTERIORE Ø 125 mm
Cod. RU-017



SOLO FORCELLA PORTARUOTA CON FRENO
Cod. RU-018

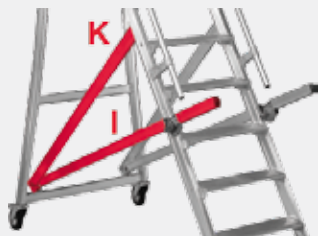

DIAGONALI TIPO I

Il n. dopo la barra identifica la misura della scala. Esclusa maniglia

Cod. CA-DI / 50-75-100-125-150-175-200

Cod. CA-DI / 225-250-275-300-325-350

Cod. CA-DI / 375-400-425-450-500

DIAGONALI TIPO K (DA 250)

Il numero dopo la barra identifica la misura della scala

Cod. CA-DK / 250-275-300-325-350

Cod. CA-DK / 375-400-425-450-500

MONTANTE ANTERIORE FORATO

DX/SX senza ferramenta

Cod. CA-MONT / 50-75-100-125-150-175-200-225-250

Cod. CA-MONT / 275-300-325-350-375-400-425-450-500

RETRO TELAIO SALDATO

Senza ferramenta e senza ruote

Cod. CA-RE / 50-75-100-125-150-175-200-225-250

Cod. CA-RE / 275-300-325-350-375-400-425-450-500



COPRIFESTA PER FASCIA FERMAPIEDI E PEDANA
Dimensioni: 18 x 150. Colore: verde
Cod. PL-116

CASTÀ / PLATEA

VASCHETTA PORTA OGGETTI ARANCIO
Cod. PL-017



PEDANA IN ALLUMINIO FUSO
Cod. FU-038



SOLO MANIGLIONE PIEGHEVOLE CON IMPUGNATURA SENZA SUPPORTI
Cod. CTA-MANIG



SUPPORTO MANIGLIONE PIEGHEVOLE IN ALLUMINIO DX
Cod. CTA-SMANIG/DX



SUPPORTO MANIGLIONE PIEGHEVOLE IN ALLUMINIO SX
Cod. CTA-SMANIG/SX

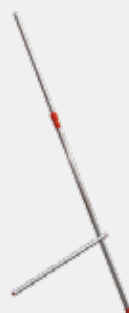

STABILIZZATORE TELESCOPICO PER CTA-4
Cod. CTA-STAB4
(Specificate DX/SX)

STABILIZZATORE TELESCOPICO PER CTA-5
Cod. CTA-STAB5
(Specificate DX/SX)

STABILIZZATORE TELESCOPICO PER CTA-6
Cod. CTA-STAB6
(Specificate DX/SX)

STABILIZZATORE TELESCOPICO PER CTA-7
Cod. CTA-STAB7
(Specificate DX/SX)

STABILIZZATORE TELESCOPICO PER CTA-8
Cod. CTA-STAB8
(Specificate DX/SX)

STABILIZZATORE TELESCOPICO PER CTA-9
Cod. CTA-STAB9
(Specificate DX/SX)

STABILIZZATORE TELESCOPICO PER CTA-10
Cod. CTA-STAB10
(Specificate DX/SX)

STABILIZZATORE TELESCOPICO PER CTA-11
Cod. CTA-STAB11
(Specificate DX/SX)



COMPASSO ANTI DIVARICAMENTO

LUNGHEZZA 860mm CTA 4/5

Cod. CTA-COMP860

LUNGHEZZA 1050mm CTA 6/7

Cod. CTA-COMP1050

LUNGHEZZA 1240mm CTA 8/9

Cod. CTA-COMP1240

LUNGHEZZA 1450mm CTA 10/11

Cod. CTA-COMP1450



PARACORPO FRONTALE ACCIAIO

Cod. CTA-PAR

CINGHIA ANTI DIVARICAMENTO CTA-3

Cod. NA-044

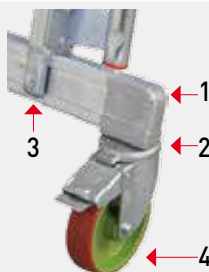

1-FUSIONE RETRO PORTA RUOTA

DESTRA: **Cod. FU-203DX**

SINISTRA: **Cod. FU-203SX**

2-PIATTELLO COPRI RUOTA ALLUMINIO FUSO

Cod. FU-205

3-FORCELLA PORTA BARRA STABILIZZATRICE

ALLUMINIO FUSO

Cod. FU-114/A

4-RUOTA RETRO Ø125 mm C/FRENO

Cod. RU-008

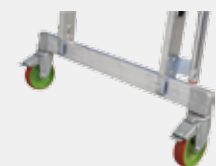

BARRA STABILIZZATRICE COMPLETA DI 2 FUSIONI PORTA RUOTA + 2 PIATTELLI COPRI RUOTA (PORTA RUOTE E RUOTE ESCLUSE)

LUNGHEZZA 810 mm CTA 3/4/5/6

Cod. CTA-BARRA810

LUNGHEZZA 1055 mm CTA 7/8

Cod. CTA-BARRA1055

LUNGHEZZA 1265 mm CTA 9/10

Cod. CTA-BARRA1265

LUNGHEZZA 1385 mm CTA 11

Cod. CTA-BARRA1385



1-RUOTA ANTERIORE Ø80 mm C/PERNO

ACCIAIO + MOLLA

Cod. RU-010/P



2-PORTA RUOTA ANTERIORE IN FUSIONE

ALLUMINIO

Cod. FU-207



MANCORRENTE 670 PER CTA-4

SENZA SUPPORTI

Cod. CTA-MAN670

MANCORRENTE 900 PER CTA-5

SENZA SUPPORTI

Cod. CTA-MAN900

MANCORRENTE 1150 PER CTA-6

SENZA SUPPORTI

Cod. CTA-MAN1150

MANCORRENTE 1410 PER CTA-7

SENZA SUPPORTI

Cod. CTA-MAN1410

MANCORRENTE 1680 PER CTA-8

SENZA SUPPORTI

Cod. CTA-MAN1680

MANCORRENTE 1920 PER CTA-9

SENZA SUPPORTI

Cod. CTA-MAN1920

MANCORRENTE 2150 PER CTA-10

SENZA SUPPORTI

Cod. CTA-MAN2150

MANCORRENTE 2400 PER CTA-11

SENZA SUPPORTI

Cod. CTA-MAN2400

1-RETRO C/CERNIERE + FORCELLE

CTA-3: **Cod. CTA-RE/3**

CTA-4: **Cod. CTA-RE/4**

CTA-5: **Cod. CTA-RE/5**

CTA-6: **Cod. CTA-RE/6**

CTA-7: **Cod. CTA-RE/7**

CTA-8: **Cod. CTA-RE/8**

CTA-9: **Cod. CTA-RE/9**

CTA-10: **Cod. CTA-RE/10**

CTA-11: **Cod. CTA-RE/11**



2-DAVANTI DI SALITA SENZA VASCHETTA/ PEDANA/PORTA RUOTA

CTA-3: **Cod. CTA-ANT/3**

CTA-4: **Cod. CTA-ANT/4**

CTA-5: **Cod. CTA-ANT/5**

CTA-6: **Cod. CTA-ANT/6**

CTA-7: **Cod. CTA-ANT/7**

CTA-8: **Cod. CTA-ANT/8**

CTA-9: **Cod. CTA-ANT/9**

CTA-10: **Cod. CTA-ANT/10**

CTA-11: **Cod. CTA-ANT/11**

S/15



COPPIA DI MANIGLIONI S/15 VERTICALI
COMPLETI DI INNESTI VERTICALI
Cod. S15-MCVER



COPPIA DI MANIGLIONI S/15 CURVATI
COMPLETI DI INNESTI
Cod. S15-MCSTD



INNESTO PER MANIGLIONE S/15 DRITTO
Cod. FE-028

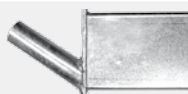

INNESTO PER MANIGLIONE S/15 VERTICALE
Cod. FE-028/B

RINFORZO SALDATO PER S/15 PER MISURE MAXI FUORI SERIE
Cod. S15/ES-013



DISTANZIALE A MURO COMPLETO DI RUOTA
Cod. FE-182

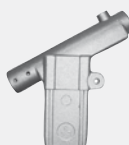

CERNIERA ANTERIORE IN ALLUMINIO SX
Cod. FU-019
CERNIERA ANTERIORE IN ALLUMINIO DX
Cod. FU-020



CERNIERA IN ALLUMINIO RETRO
Cod. FU-021
CERNIERA IN ACCIAIO PER PEDANA
Cod. FE-002
CATENELLA DI PROTEZIONE CON
MOSCHETTONE
Cod. CA-CT



1-RUOTA ANTERIORE Ø80 mm C/PERNO
ACCIAIO + MOLLA
Cod. RU-010/P



PORTA RUOTA ANTERIORE IN FUSIONE
ALLUMINIO
Cod. FU-207

BINARY

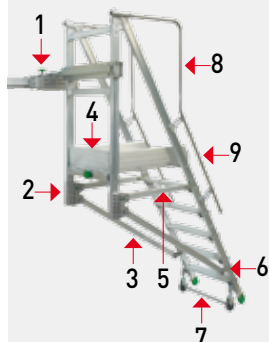

1- CARRELLO DI SCORRIMENTO IN
ALLUMINIO FUSO CON VOLANTINI +
CUSCINETTI

Cod. FU-124

SOLO VOLANTINO C/INSERTO PER
CARRELLO

Cod. PL-333

2- GIUNZIONE GRANDE A DUE VIE
ALLUMINIO FUSO

Cod. FU-122

3- DIAGONALE (SPECIFICARE IL MODELLO)

Cod. BY-DIAG

4- PEDANA ESCLUSO MOLLETTONE
ACCIAIO

Cod. CA-PED

MOLLETTONE ACCIAIO SOTTO PEDANA

Cod. FE-002

5- TRAVERSA ORIZZONTALE CON GIUNTO
METALLICO ACCIAIO

Cod. BY-TRAV

6- GIUNZIONE PICCOLA ALLUMINIO FUSO

Cod. FU-123

7- TUBETTO DI COLLEGAMENTO TRA
RUOTE

Cod. BY-COLL

8- PARACORPO

Cod. CA-MAS

9- RINGHIERA (SPECIFICARE IL MODELLO)

Cod. MAN

SUPPORTO MANCORRENTE FISSO

Cod. FU-016

SPAZIO



VOLANTINO ZINCATO PER TRAVERSE DI BASE
"SPAZIO"
Cod. SPA-VOL



VOLANTINO PER LIVELLATORI
Colore: verde
Cod. PL-031



RUOTA BASE CON FRENO "SPAZIO"
Diametro: 200
Cod. RU-004

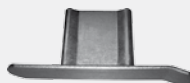

INNESTI PER PIANI "SPAZIO"
Cod. FE-016

1- TRAVERSA DI BASE
Cod. STRB

2- TESTATA DI BASE CON DUE RUOTE CON FRENO
Cod. STB

3- LIVELLATORE TELESCOPICO
Cod. SL

4- SPALLA 125 CM (5 TRAVERSINI)
Cod. SS1

5- SPALLA 65 CM (PER PALCHETTO 3 TRAVERSINI)
Cod. SS2

6- TRAVERSA LATERALE
Cod. ST

7- SAETTA PER ALZATA
Cod. SSA1

8- SAETTA ROSSA PER PALCHETTO
Cod. SSA2

9- MANIGLIONE ROSSO TERMINALE
Cod. SMT

10- TRAVERSINO LATERALE ROSSO PER PALCHETTO
Cod. STT

11- SAETTINO DIAGONALE DI BASE
Cod. SSB

12- TIRANTE VERTICALE ROSSO PER ALZATA
Cod. STA

13- TIRANTE VERTICALE ROSSO PER PALCHETTO
Cod. STI

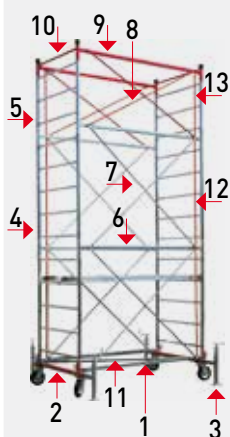

MITO

1- SPALLA LATERALE 100 CM
Cod. S100/M

2- SPALLA LATERALE 200 CM
Cod. S200/M

3- TESTATA DI BASE CON RUOTE FRENANTI
Cod. BCR/M

4- TRAVERSA CON 4 SAETTE
Cod. TRV/M

5- STABILIZZATORE
Cod. STB/M

6- LIVELLATORE
Cod. AMLV

7- MANIGLIONE TERMINALE CON SAETTE
Cod. MT/M

8- RINGHIERA DI PROTEZIONE
Cod. RP/M

9- SAETTA ROSSA PER MITO
Cod. MI SAETTA

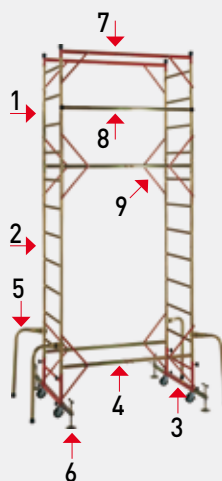

VOLANTINO PER RINGHIERA DI PROTEZIONE
Cod. PL-120



ELEMENTO PER ZOPPO REGOLABILE
Cod. ELZ/M

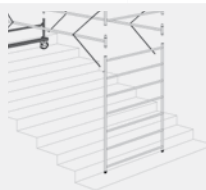

CONFEZIONE DI 2 PIANI DI LAVORO IN LEGNO VERNICIATO
Cod. PLSL/M



VOLANTINO PER LIVELLATORI
Colore: verde
Cod. PL-031



RUOTA BASE CON FRENO "MITO"
Diametro: 125
Cod. RU-013



PONY

1- COPPIA ASSI
Cod. LE-002

2- COPPIA SAETTE

3- MANIGLIONE

4- SPALLA SENZA RUOTE

5- SPALLA CON RUOTE

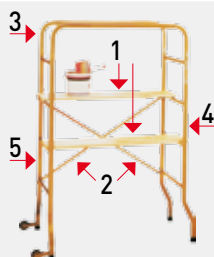

ALUMITO / ALUMAXI

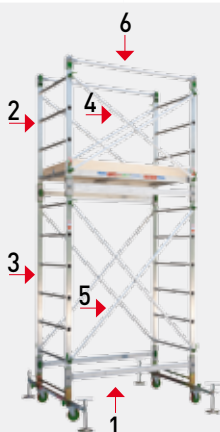

1- TRAVERSA DI BASE/LATERALE
Cod. AMTL

2- SPALLA A 4 GRADINI
H 1200 mm
Cod. AMSP-4

3- SPALLA A 6 GRADINI
H 1800 mm
Cod. AMSP-6

4- SAETTA 1750 MM
Per alzata 1200
Cod. AMS-17

5- SAETTA 2100 MM
Per alzata 1800
Cod. AMS-21

6- MANIGLIONE TERMINALE
Cod. AM-MA



TESTATA DI BASE CON RUOTE
Cod. AMTB



LIVELLATORE A VITE
Cod. AMLV



RUOTA CON FRENO
Diametro: 125
Cod. RU-013



RACCORDO A CROCERA IN FUSIONE PER
TRAVERSA
Compreso tirante
Cod. D674-C

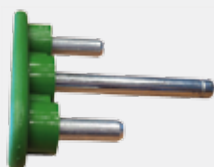

TIRANTE A MOLLA PER CROCERA
Colore: verde
Cod. PL-064



FUNGO A PRESSIONE LUNGO PER ATTACCO
SAETTA
Cod. PL-306L



MORSETTO IN ALLUMINIO PER
STABILIZZATORE COMPLETO DI VOLANTINI
Cod. D672

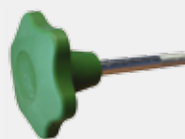

SOLO VOLANTINO LUNGO PER MORSETTO
Cod. PL-312



SOLO VOLANTINO CORTO PER LIVELLATORE
Cod. PL-031

PINNA/PINNA CLIC/ PINNA CLIC•CLAC



PIANO DI LAVORO COMPLETO
Cod. PIAN-PN



CONGIUNZIONE DIAGONALE C/2 ESPANSORI
Cod. PN-SAET1555



CONGIUNZIONE ORIZZONTALE C/2 ESPANSORI
Cod. PN-SAET1440

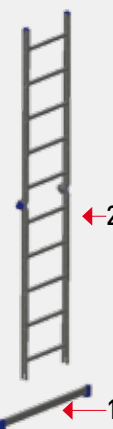

1-BARRA STABILIZZATRICE C/2 PIEDI GOMMA
Cod. BA-PN1207

2-FIANCATA C/PROLUNGA + 2 CERNIERE
Cod. PN-FIAN

Specificare c/fori x ruote - s/fori per ruote

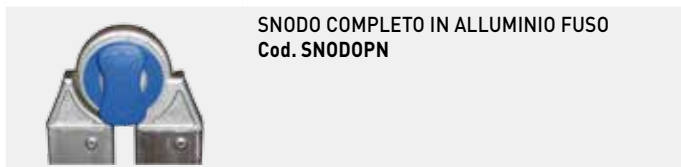

SNODO COMPLETO IN ALLUMINIO FUSO
Cod. SNODOPN



1-PORTE RUOTA SOLLEVABILE IN ACCIAIO (PINNA) SENZA RUOTA

DESTRO: Cod. FE-177/DX

SINISTRO: Cod. FE-177/SX

SOLO RUOTA GOMMA NERA Ø150 MM
Cod. RU-035

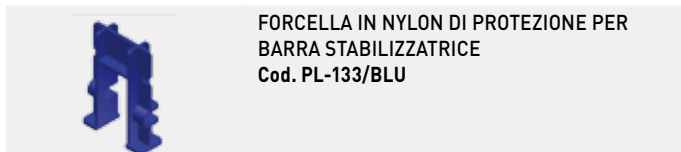

FORCELLA IN NYLON DI PROTEZIONE PER BARRA STABILIZZATRICE
Cod. PL-133/BLU

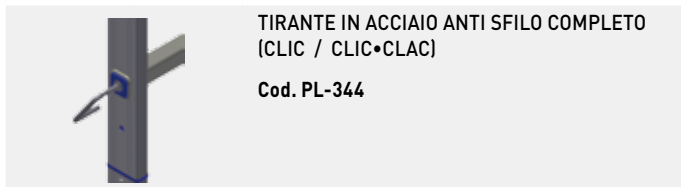

TIRANTE IN ACCIAIO ANTI SFILO COMPLETO (CLIC / CLIC•CLAC)

Cod. PL-344

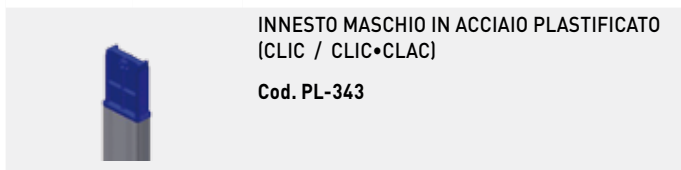

INNESTO MASCHIO IN ACCIAIO PLASTIFICATO (CLIC / CLIC•CLAC)

Cod. PL-343

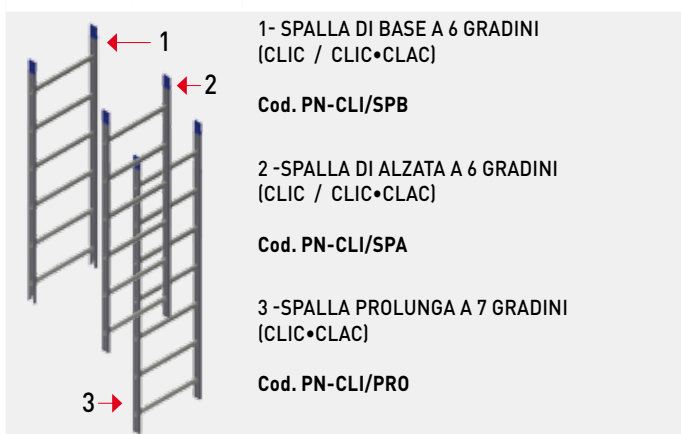

1- SPALLA DI BASE A 6 GRADINI (CLIC / CLIC•CLAC)

Cod. PN-CLI/SPB

2- SPALLA DI ALZATA A 6 GRADINI (CLIC / CLIC•CLAC)

Cod. PN-CLI/SPA

3- SPALLA PROLUNGA A 7 GRADINI (CLIC•CLAC)

Cod. PN-CLI/PRO

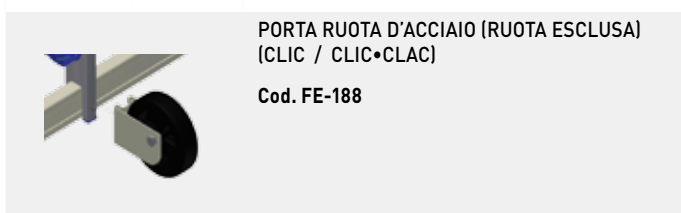

PORTA RUOTA D'ACCIAIO (RUOTA ESCLUSA) (CLIC / CLIC•CLAC)

Cod. FE-188



STABILIZZATORE TELESCOPICO (CLIC•CLAC)

Cod. PN-STAB

ALTO

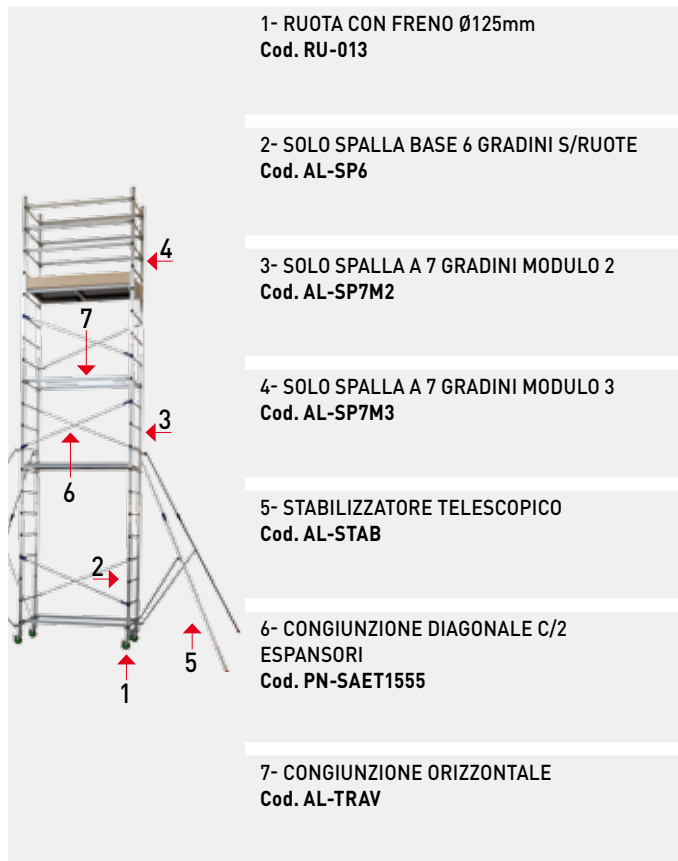

1- RUOTA CON FRENO Ø125mm
Cod. RU-013

2- SOLO SPALLA BASE 6 GRADINI S/RUOTE
Cod. AL-SP6

3- SOLO SPALLA A 7 GRADINI MODULO 2
Cod. AL-SP7M2

4- SOLO SPALLA A 7 GRADINI MODULO 3
Cod. AL-SP7M3

5- STABILIZZATORE TELESCOPICO
Cod. AL-STAB

6- CONGIUNZIONE DIAGONALE C/2 ESPANSORI
Cod. PN-SAET1555

7- CONGIUNZIONE ORIZZONTALE
Cod. AL-TRAV



8- PIANO DI LAVORO CON BOTOLA
Cod. AL-PIA

9- FASCIA FERMAPIEDE PIEGHEVOLE
Cod. LE-033

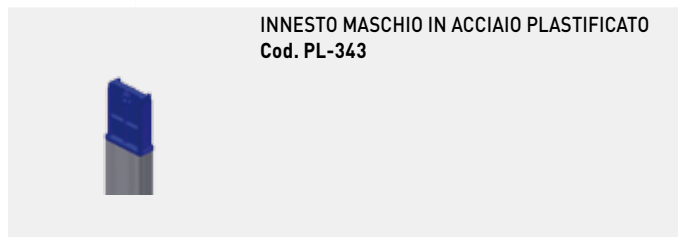

INNESTO MASCHIO IN ACCIAIO PLASTIFICATO
Cod. PL-343



TIRANTE IN ACCIAIO ANTI SFILO COMPLETO
Cod. PL-344



SUPPORTO RUOTA IN FUSIONE C/FILETTO
Cod. FU-209

PIATTELLO COPRI RUOTA IN FUSIONE
Cod. FU-028

PENNY

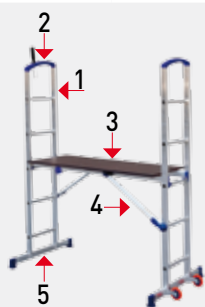

- 1- SPALLA COMPLETA
Cod. PE-SPA
- 2- PARACORPO PORTA OGGETTI IN RESINA
Cod. PL-350
- 3- PIANO DI LAVORO CON 2 DIAGONALI
Cod. PE-PIAN
- 4- SOLO DIAGONALE COMPLETA
Cod. PE-DIAG
- 5- BARRA STABILIZZATRICE
Cod. PE-BARRA

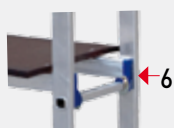

- 6- FERMO DI SICUREZZA IN ACCIAIO PER AGGANCIAMENTO DEL PIANO
Cod. FE-220



- RUOTA Ø 90 mm
Cod. RU-036



- PORTA RUOTA CON RUOTA
Cod. FE-192



- GANCIO IN NYLON FISSA PIANO S/FERMO DI SICUREZZA
Cod. PL-346

TANO

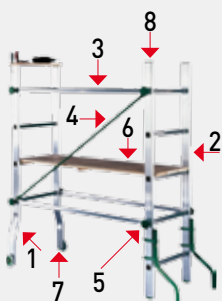

- 1- SPALLA A 4 GRADINI CON RUOTE
Cod. TA-SPCR
- 2- SPALLA A 5 GRADINI SENZA RUOTE
Cod. TA-SPSR
- 3- CONGIUNZIONE ORIZZONTALE 1400 mm
Cod. TA-TR0
- 4- CONGIUNZIONE DIAGONALE 1650 mm
Cod. TA-TRD
- 5- VOLANTINO NYLON CON FILETTO
Cod. PL-031
- 6- PIANO DI LAVORO A DOGHE IN LEGNO
Cod. LE-012
- 7- PIEDE DI CHIUSURA 25X65 mm PIANO C/ FORO FISSA RUOTA
Cod. PL-303
- 8- TAPPO COPRI TESTA 25X65 mm
Cod. PL-037



- TASSELLO CON INSERTO FILET. PER VOLANTINO
Cod. PL-309



- STABILIZZATORE VERDE
Cod. TA-STBV



- MENSOLA PORTA-ATTREZZI LEGNO
Cod. TA-ME

ESTRO

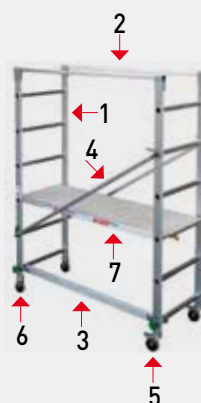

- 1- SPALLA CON RUOTE
Cod. ES-SP
- 2- MANIGLIONE TERMINALE
Cod. PI-MA
- 3- TRAVERSA DI BASE
Cod. ES-TR
- 4- CONGIUNZIONE DIAGONALE
Cod. ES-SA
- 5- RUOTA CON FRENO
Cod. RU-027
- 6- RUOTA SENZA FRENO
Cod. RU-029
- 7- TAVOLA PIANALE
Cod. ES-TA



- FUNGO A PRESSIONE PER MOLLA/SAETTA
Cod. PL-306

PIEGO/Special PIEGO

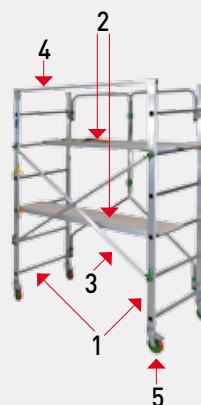

- 1- STRUTTURA CON RUOTE
Cod. PI-ST
- 2- CONFEZIONE DUE TAVOLE
Cod. LE-001
- 3- CONGIUNZIONE DIAGONALE
Cod. PI-SA
- 4- MANIGLIONE TERMINALE
Cod. PI-MA
- 5- RUOTA CON FRENO Ø 125 mm
Cod. RU-013
- SACCA PORTA ACCESSORI
Cod. SA-001
- TAVOLA UNICA SPECIAL PIEGO 680x1525 mm
Cod. LE-015

DOGE/65



RUOTA Ø 150 MM CON FRENO
Cod. RU-025



BLOCCO FUSIONE PORTA RUOTA
Cod. FU-026



INNESTO IN ACCIAIO PLASTIFICATO
Cod. PL-300



RACCORDO A CROCERA IN FUSIONE PER
TRAVERSA (CON TIRANTI A MOLLA)
Cod. D674-C

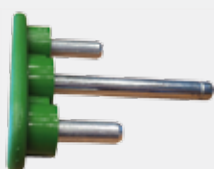

TIRANTE A MOLLA PER CROCERA
Cod. PL-064



FUNGO A PRESSIONE PER SPALLA
Cod. PL-306L



MOLLA INOX PER SAETTA
Cod. PL-307



MORSETTO PER STABILIZZATORE CON
VOLANTINI
Cod. D672



SOLO VOLANTINO LUNGO DEL MORSETTO
STABILIZZATORE
Cod. PL-312



VOLANTINO CORTO PER LIVELLATORE
Cod. PL-031



GANCIO ANTI VENTO
Cod. FU-032



GANCIO DI SUPPORTO PIANO DI LAVORO
Cod. D6/ES-109



PIEDE A GOCCIA VERDE Ø 50 MM PER
STABILIZZATORE
Cod. PL-301



COPRITESTA ALETTATO VERDE Ø 50 MM PER
STABILIZZATORE
Cod. PL-219

DOGE/80



RUOTA Ø 200 MM CON FRENO
Cod. RU-034



BLOCCO FUSIONE PORTA RUOTA
Cod. FU-045



INNESTO IN ACCIAIO PLASTIFICATO
Cod. PL-320

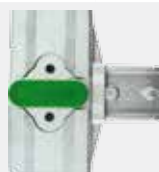

RACCORDO A CROCERA IN FUSIONE PER
TRAVERSA (CON TIRANTI A MOLLA)
Cod. D823

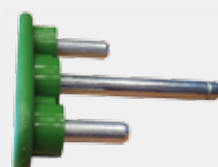

TIRANTE A MOLLA PER CROCERA
Cod. PL-064



FUNGO A PRESSIONE PER SPALLA
Cod. PL-299



MOLLA INOX PER SAETTA
Cod. PL-307



MORSETTO PER STABILIZZATORE CON
VOLANTINI
Cod. D828

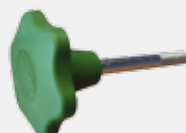

SOLO VOLANTINO LUNGO DEL MORSETTO
STABILIZZATORE
Cod. PL-312

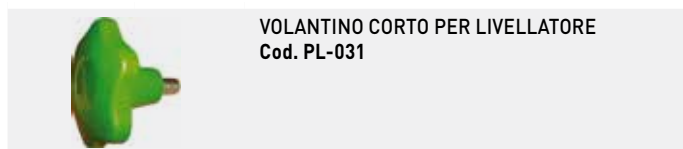

VOLANTINO CORTO PER LIVELLATORE
Cod. PL-031

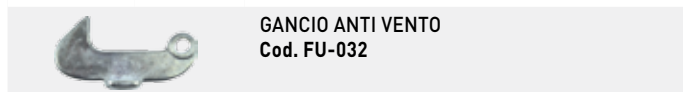

GANCIO ANTI VENTO
Cod. FU-032

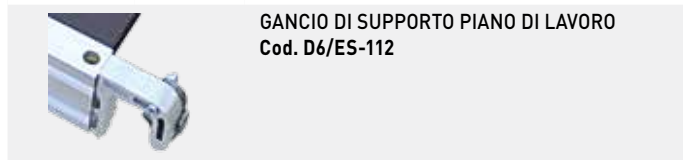

GANCIO DI SUPPORTO PIANO DI LAVORO
Cod. D6/ES-112

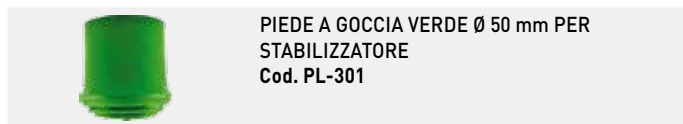

PIEDE A GOCCIA VERDE Ø 50 mm PER
STABILIZZATORE
Cod. PL-301

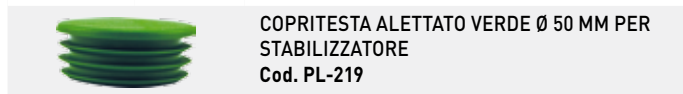

COPRITESTA ALETTATO VERDE Ø 50 mm PER
STABILIZZATORE
Cod. PL-219

EURODOMUS

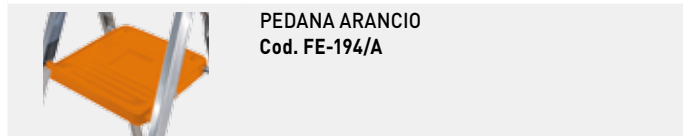

PEDANA ARANCIO
Cod. FE-194/A

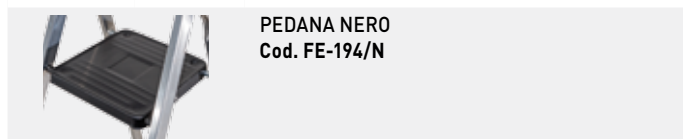

PEDANA NERO
Cod. FE-194/N

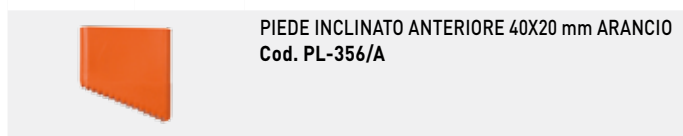

PIEDE INCLINATO ANTERIORE 40X20 mm ARANCIO
Cod. PL-356/A

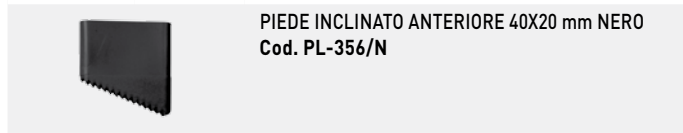

PIEDE INCLINATO ANTERIORE 40X20 mm NERO
Cod. PL-356/N

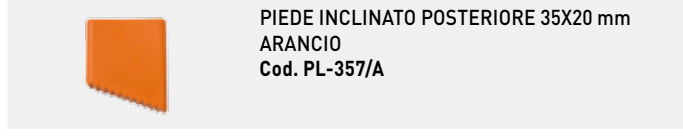

PIEDE INCLINATO POSTERIORE 35X20 mm
ARANCIO
Cod. PL-357/A

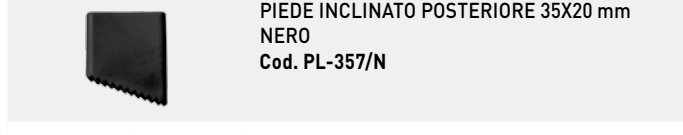

PIEDE INCLINATO POSTERIORE 35X20 mm
NERO
Cod. PL-357/N

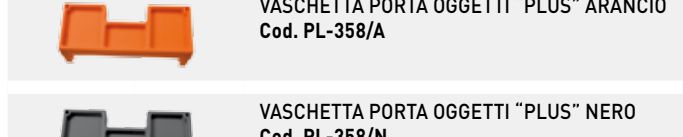

VASCHETTA PORTA OGGETTI "PLUS" ARANCIO
Cod. PL-358/A

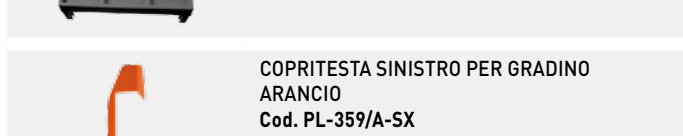

VASCHETTA PORTA OGGETTI "PLUS" NERO
Cod. PL-358/N



COPRITESTA SINISTRO PER GRADINO
ARANCIO
Cod. PL-359/A-SX



COPRITESTA DESTRO PER GRADINO ARANCIO
Cod. PL-359/A-DX

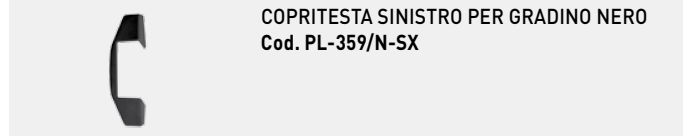

COPRITESTA SINISTRO PER GRADINO NERO
Cod. PL-359/N-SX

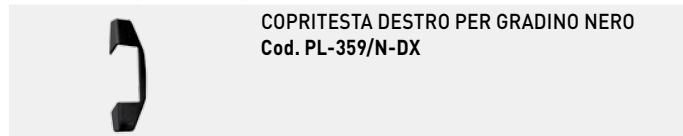

COPRITESTA DESTRO PER GRADINO NERO
Cod. PL-359/N-DX

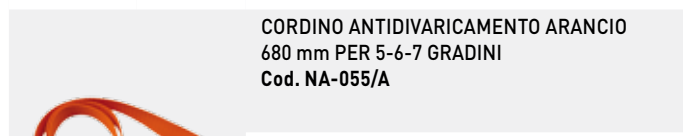

CORDINO ANTIDIVARICAMENTO ARANCIO
680 mm PER 5-6-7 GRADINI
Cod. NA-055/A

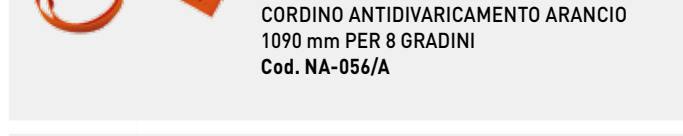

CORDINO ANTIDIVARICAMENTO ARANCIO
1090 mm PER 8 GRADINI
Cod. NA-056/A

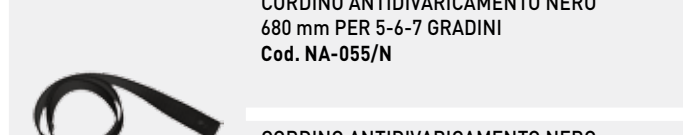

CORDINO ANTIDIVARICAMENTO NERO
680 mm PER 5-6-7 GRADINI
Cod. NA-055/N

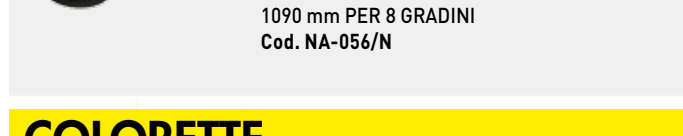

CORDINO ANTIDIVARICAMENTO NERO
1090 mm PER 8 GRADINI
Cod. NA-056/N

COLORETTE



PIEDE ANTERIORE 35X20 mm NERO
Cod. PL-360/N



PIEDE ANTERIORE 35X20 mm ARANCIO
Cod. PL-360/A

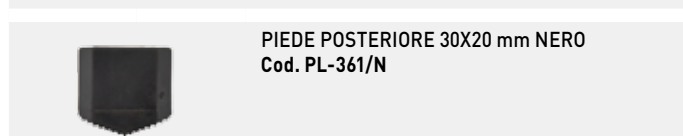

PIEDE POSTERIORE 30X20 mm NERO
Cod. PL-361/N

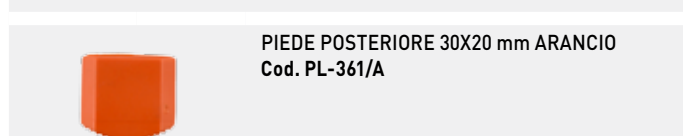

PIEDE POSTERIORE 30X20 mm ARANCIO
Cod. PL-361/A

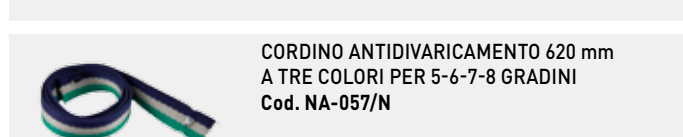

CORDINO ANTIDIVARICAMENTO 620 mm
A TRE COLORI PER 5-6-7-8 GRADINI
Cod. NA-057/N

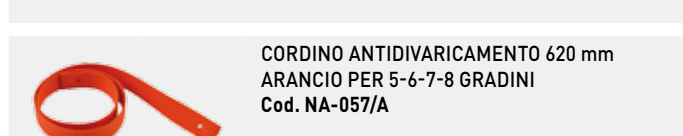

CORDINO ANTIDIVARICAMENTO 620 mm
ARANCIO PER 5-6-7-8 GRADINI
Cod. NA-057/A

FILO



PIEDE INCLINATO ANTERIORE 40X20 mm ARANCIO
Cod. PL-356/A



PIEDE INCLINATO POSTERIORE 35X20 mm ARANCIO
Cod. PL-357/A



CORDINO DI SICUREZZA 20mm
Cod. NA-066 | 2+2 - 202mm
Cod. NA-067 | 3+3/4+4 - 380mm
Cod. NA-068 | 5+5 - 540mm
Cod. NA-069 | 6+6/7+7 - 710mm



DIAGONALE DI RINFORZO
Cod. FE-226



CERNIERA D'ACCIAIO COMPLETA (DX+SX)
Cod. FE-223

TINTO / TONTO



SOLO PEDANA PLASTICA NERA TONTO
Cod. PL-371



GRADINO GRIGIO TONTO + PLASTICA NERA
Cod. FE-217



GRADINO BIANCO TONTO + PLASTICA NERA
Cod. FE-218



PIEDE ANGOLARE RETRO TONTO NERO
Cod. PL-370



FERMO DI SICUREZZA TONTO
Cod. PL-369



PIEDE ANTERIORE TONTO Ø mm NERO
Cod. PL-368



CERNIERA ZINCATA TONTO
Cod. FE-219



CERNIERA TINTO ARANCIO
Cod. PL-367



GRADINO TINTO NERO LUCIDO
Cod. FE-216



PIATTO DIAGONALE (SOLO TINTO-3)
Cod. FE-215



DISTANZIALE GRADINO TINTO ARANCIO
Cod. PL-366



PIEDE ANTERIORE INCLINATO TINTO 20X30 mm ARANCIO
Cod. PL-365



PIEDE ANGOLARE RETRO TINTO ARANCIO
Cod. PL-364



PIEDE RETRO (SOLO TINTO-4) ARANCIO
Cod. 372

PLIO



PIEDE DI BASE SAGOMATO ANTERIORE
Cod. PL-336



PIEDE DI BASE PER MONTANTE RETRO
Cod. PL-382



TAPPO 25X65 PER MONTANTE RETRO
Cod. PL-037

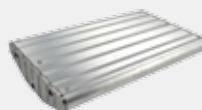

GRADINO COMPLETO DI FUSIONI
Cod. ES-POG1



TRAVERSINO DI RINFORZO ANTERIORE 408mm
Cod. FE-235



SAETTA DI ARTICOLAZIONE LATERALE 376mm
Cod. FE-176

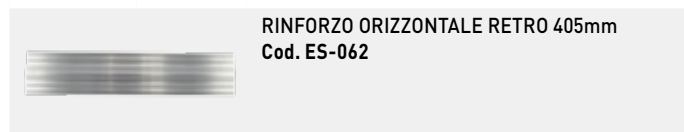

RINFORZO ORIZZONTALE RETRO 405mm
Cod. ES-062

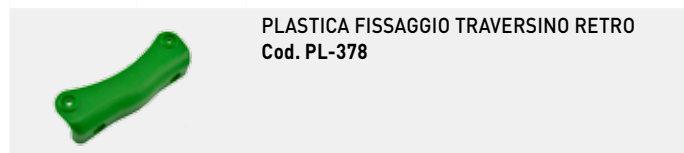

PLASTICA FISSAGGIO TRAVERSINO RETRO
Cod. PL-378



MANIGLIONE TELESCOPICO
Cod. ES-POMN

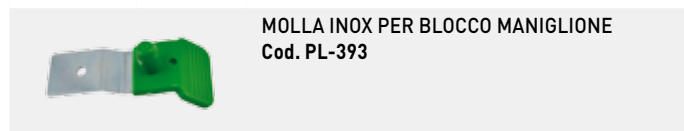

MOLLA INOX PER BLOCCO MANIGLIONE
Cod. PL-393

ALTRI RICAMBI GENERICI

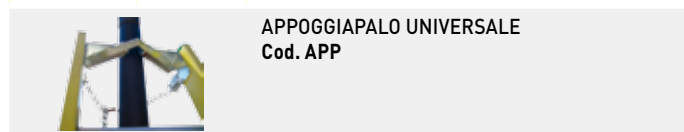

APPOGGIAPALO UNIVERSALE
Cod. APP

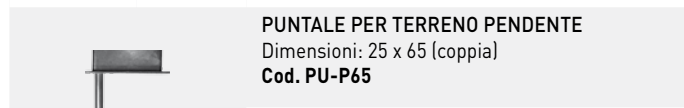

PUNTALE PER TERRENO PENDENTE
Dimensioni: 25 x 65 (coppia)
Cod. PU-P65

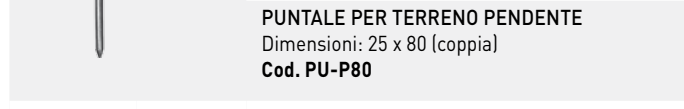

PUNTALE PER TERRENO PENDENTE
Dimensioni: 25 x 80 (coppia)
Cod. PU-P80

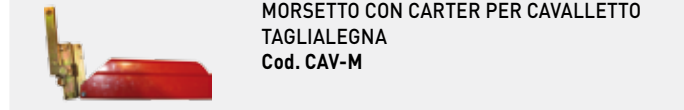

MORSETTO CON CARTER PER CAVALLETTO
TAGLIALEGNA
Cod. CAV-M

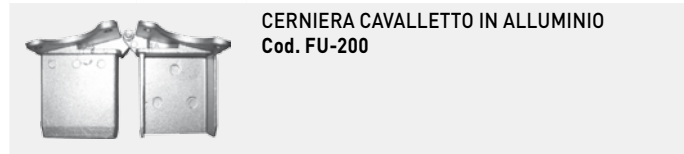

CERNIERA CAVALLETTO IN ALLUMINIO
Cod. FU-200

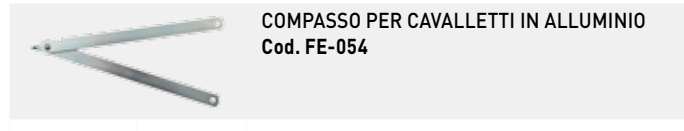

COMPASSO PER CAVALLETTI IN ALLUMINIO
Cod. FE-054

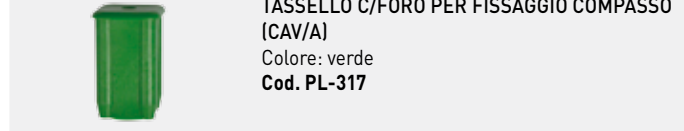

TASSELLO C/FORO PER FISSAGGIO COMPASSO
(CAV/A)
Colore: verde
Cod. PL-317

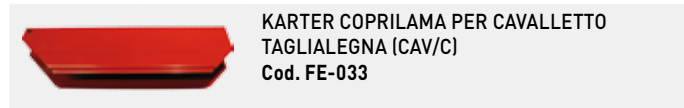

KARTER COPRILAMA PER CAVALLETTO
TAGLIALEGNA (CAV/C)
Cod. FE-033

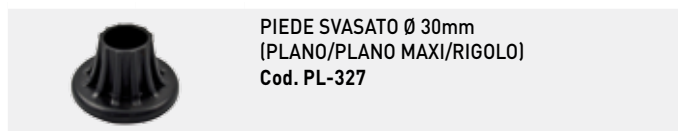

PIEDE SVASATO Ø 30mm
(PLANO/PLANO MAXI/RIGOLO)
Cod. PL-327

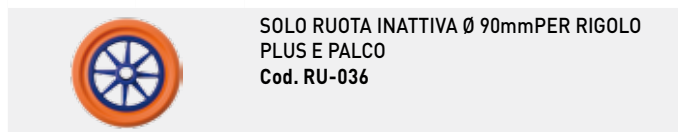

SOLO RUOTA INATTIVA Ø 90mm PER RIGOLO
PLUS E PALCO
Cod. RU-036

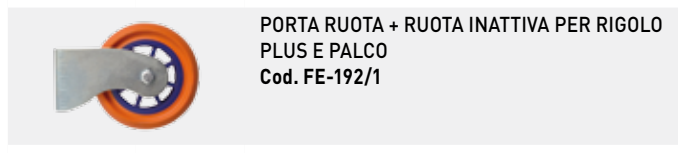

PORTA RUOTA + RUOTA INATTIVA PER RIGOLO
PLUS E PALCO
Cod. FE-192/1

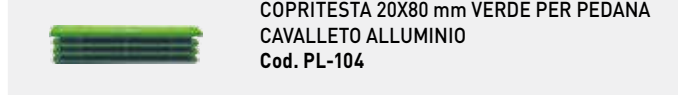

COPRITESTA 20X80 mm VERDE PER PEDANA
CAVALLETO ALLUMINIO
Cod. PL-104