

EURO TRABATTELLO CAPO-1

CAPO 1 è trabattello d'alluminio in tubo Ø 50 mm saldato. Di contenute dimensioni indicato per lavori edili, decorazioni, impiantistica sia in interni che esterni.

Montaggio rapidissimo con congiunzioni diagonali e verticali ad aggancio automatico in alluminio fuso. Tre varianti di basi disponibili:

- Fissa standard • Pieghevole • Livellante

BASE STANDARD

Cod. C1-BST

2 testate di base con ruote + 2 spalle 6 gradini + 2 orizzontali + 2 diagonali

kg: 28,50 kg, m³: 0,21 m³, Colli: 1
EAN 8028406103509

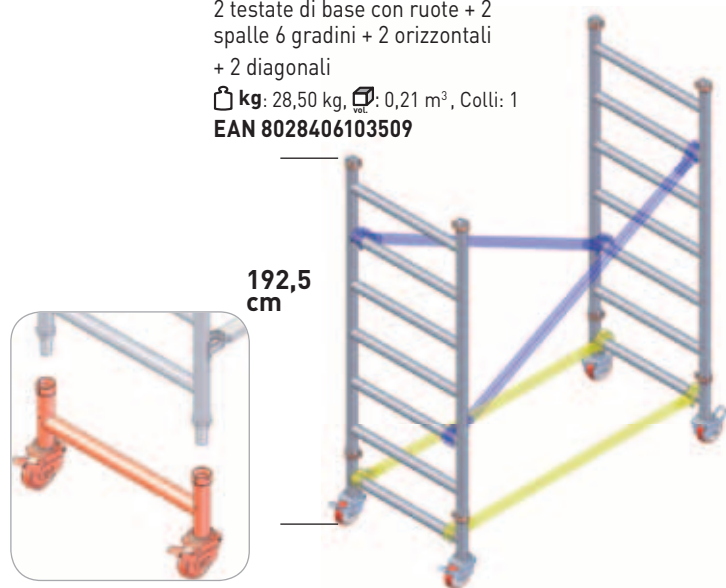

BASE PIEGHEVOLE

Cod. C1-BPI

2 testate di base con ruote + 2 spalle 6 gradini + 1 cancelletto di base + 1 traversa orizzontale

kg: 30,40 kg, m³: 0,36 m³, Colli: 1
EAN 8028406103516



BASE LIVELLANTE

Cod. C1-BLI

2 spalle livellanti 6 gradini + 2 orizzontali + 2 diagonali

kg: 38,00 kg, m³: 0,36 m³, Colli: 1
EAN 8028406103523

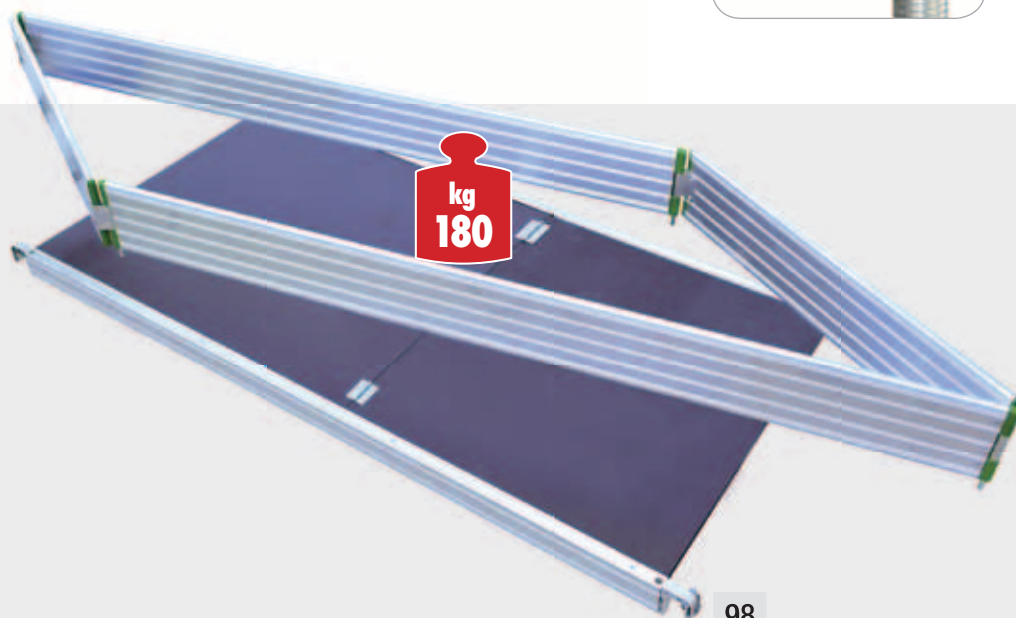
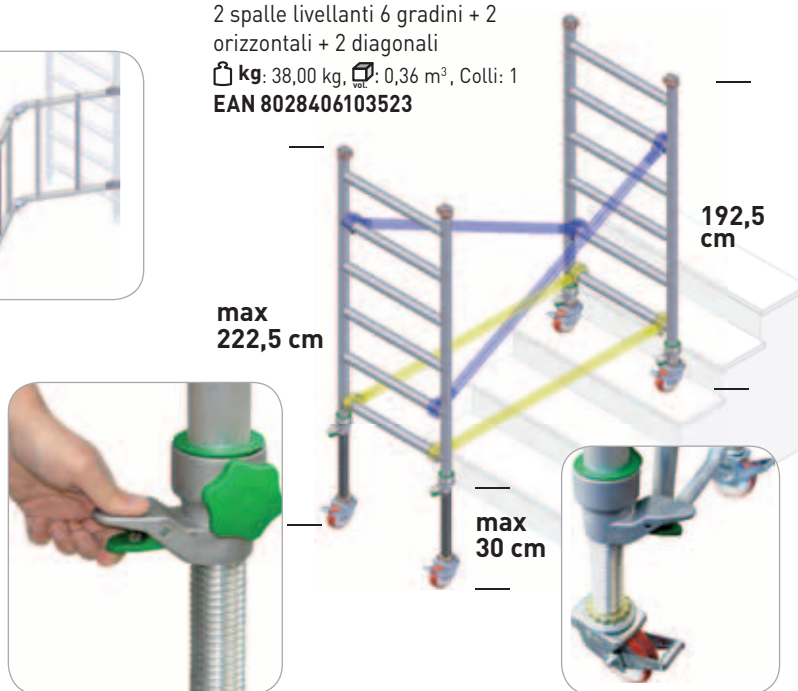

Piano in alluminio con calpestio in legno Eurodeck melaminico antiscivolo e idroresistente.

Certificato:



ESCLUSIVO: fascia fermapiedi pieghevole in alluminio, corpo unico!!





10 ANNI
GARANZIA

MADE
IN
ITALY
100%

CAPO-1

BASE:

77x161 cm

STRUTTURA:

73x156 cm

PIANO LAVORO:

60x143 cm

CLASSE 3

200 kg/m²: EN 1004

180
kg
MAX

Carico massimo inteso
ripartito su un solo piano



EN1004
EUROPEAN NORM



CERTIFICATO N. S 60080290



CERTIFICATO N.
2006/4491
2006/4492

Altezze massime di utilizzo

Altezza struttura:	11,30 m
Interno edifici:	
ultimo piano:	10,14 m
lavoro:	12,04 m
esterno edifici:	
ultimo piano:	8,00 m
lavoro:	9,90 m



Innesto
maschio-femmina
per le spalle



Aggancio automatico in
alluminio fuso



Traversini e montanti
fissati saldati



Stabilizzatori
con piedi snodati in
acciaio e gomma



Ruota Ø 150 mm
con freno a
disassamento











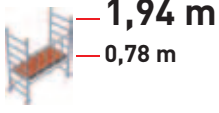
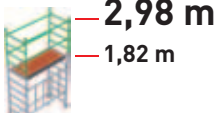

COMPONENTI PRINCIPALI

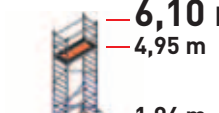
	BASE STANDARD Cod. C1-BST 2 testate di base con ruote + 2 spalle 6 gradini + 2 orizzontali + 2 diagonali ☐ kg: 28,50 ☐ m³: 0,21 m³, Colli:1 EAN 8028406103509		ALZATA h 1040 - 4 gradini Cod. C3-7515 2 spalle + 2 diagonali ☐ kg: 12, ☐ m³: 0,120 m³, Colli:1 EAN 8028406103240		PIANO DI LAVORO c/fermapiede Cod. C7-7515 in alluminio con botola ☐ kg: 20,80, ☐ m³: 0,103 m³, Colli:2 EAN 8028406103288
	BASE PIEGHEVOLE Cod. C1-BPI 2 testate di base con ruote + 2 spalle 6 gradini + 1 cancelletto di base + 1 traversa orizzontale ☐ kg: 30,40 ☐ m³: 0,36 m³, Colli: 1 EAN 8028406103516		ALZATA h 1560 - 6 gradini Cod. C2-7515 2 spalle + 2 diagonali ☐ kg: 15,20, ☐ m³: 0,160 m³, Colli:1 EAN 8028406103233		PIANO DI LAVORO s/fermapiede Cod. C6-7515 in alluminio con botola ☐ kg: 14,60, ☐ m³: 0,092 m³, Colli:1 EAN 8028406103271
	BASE LIVELLANTE Cod. C1-BLI 2 spalle livellanti 6 gradini + 2 orizzontali + 2 diagonali ☐ kg: 38,00 ☐ m³: 0,21 m³, Colli: 1 EAN 8028406103523		PALCHETTO TERMINALE h 1040 - 4 gradini Cod. C5-7515 2 spalle + 4 traverse ☐ kg: 15,60, ☐ m³: 0,125 m³, Colli:1 EAN 8028406103264		PROTEZIONE ORIZZONTALE per piano di lavoro Cod. C134-7515 4 pezzi ☐ kg: 8,00, ☐ m³: 0,10 m³, Colli:1 EAN 8028406104179
			PALCHETTO TERMINALE h 1560 - 6 gradini Cod. C4-7515 2 spalle + 4 traverse ☐ kg: 18,80, ☐ m³: 0,165 m³, Colli:1 EAN 8028406103257		STABILIZZATORI 2100 mm Cod. C84-7515 4 pezzi ☐ kg: 24,00, ☐ m³: 0,18 m³, Colli:1 EAN 8028406104186

COMPONENTI SECONDARI

	TESTATA DI BASE con 2 ruote frenanti Cod. C19-7515 ☐ kg: 6,00, ☐ m³: 0,010 m³, Colli: 1 EAN 8028406103219		ORIZZONTALE 1600 mm Cod. C13-7515 ☐ kg: 1,90, ☐ m³: 0,025 m³, Colli:1 EAN 8028406103172		SPALLA PER BASE LIVELLANTE Cod. C26-7515 ☐ kg: 14,00, ☐ m³: 0,065 m³, Colli:1 EAN 8028406103226
	SOLO CANCELLETTO DI BASE a 2 ante Cod. C18-7515 ☐ kg: 6,20, ☐ m³: 0,030 m³, Colli:1 EAN 8028406103202		DIAGONALE 1800 mm Cod. C14-7515 ☐ kg: 2,00, ☐ m³: 0,027 m³, Colli:1 EAN 8028406103189		
	SPALLA h 1040 a 4 gradini Cod. C11-7515 ☐ kg: 4,00, ☐ m³: 0,040 m³, Colli:1 EAN 8028406103158		FASCIA FERMAPIEDE pieghevole in alluminio Cod. C15-7515 ☐ kg: 6,20, ☐ m³: 0,011 m³, Colli:1 EAN 8028406103196		
	SPALLA h 1560 a 6 gradini Cod. C12-7515 ☐ kg: 5,60, ☐ m³: 0,060 m³, Colli:1 EAN 8028406103165		STABILIZZATORE 2100 mm Cod. C8-7515 ☐ kg: 6,00, ☐ m³: 0,045 m³, Colli:1 EAN 8028406103141		

COMPOSIZIONI COMPLETE DI PIANALI

<p>Cod. C30-1/C</p>  <p>1,94 m 0,78 m</p> <p>Montaggio 4 min.</p>	<p>Cod. C31-1/C</p>  <p>2,98 m 1,82 m</p> <p>Montaggio 6 min.</p>	<p>Cod. C32-1/C</p>  <p>3,50 m 2,35 m</p> <p>Montaggio 8 min.</p>	<p>Cod. C33-1/C</p>  <p>4,54 m 3,38 m</p> <p>Montaggio 10 min.</p>	<p>Cod. C34-1/C</p>  <p>5,05 m 3,90 m</p> <p>Montaggio 14 min.</p>
<p>Cod. C35-1/C</p>  <p>6,10 m 4,95 m 1,94 m</p> <p>Montaggio 16 min.</p>	<p>Cod. C36-1/C</p>  <p>6,62 m 5,47 m 1,94 m</p> <p>Montaggio 18 min.</p>	<p>Cod. C37-1/C</p>  <p>7,66 m 6,50 m 3,00 m</p> <p>Montaggio 21 min.</p>	<p>Cod. C38-1/C</p>  <p>8,18 m 7,02 m 3,53 m</p> <p>Montaggio 23 min.</p>	
<p>Cod. C39-1/C</p>  <p>9,22 m 8,06 m 4,32 m</p> <p>Montaggio 26 min.</p>	<p>Cod. C40-1/C</p>  <p>9,74 m 8,58 m 5,12 m 1,94 m</p> <p>Montaggio 28 min.</p>	<p>Cod. C41-1/C</p>  <p>10,78 m 9,63 m 5,12 m 1,94 m</p> <p>Montaggio 31 min.</p>	<p>Cod. C42-1/C</p>  <p>11,30 m 10,14 m 6,44 m 2,74 m</p> <p>Montaggio 35 min.</p>	

ALTEZZA TOTALE	m	1,94	2,98	3,50	4,54	5,05	6,10	6,62	7,66	8,18	9,22	9,74	10,78	11,30
LAVORO UTILE	m	2,68	3,72	4,25	5,28	5,80	6,85	7,37	8,40	8,92	9,96	10,48	11,53	12,04
ALTEZZA ULTIMO PIANO	m	0,78	1,82	2,35	3,38	3,90	4,95	5,47	6,50	7,02	8,06	8,58	9,63	10,14

EN1004 NORMA EUROPEA	Cod.	Descrizione		Pezzi	Pezzi	Pezzi	Pezzi	Pezzi	Pezzi	Pezzi	Pezzi	Pezzi	Pezzi	Pezzi	Pezzi	Pezzi
	C3-7515	Alzata 4 gradini														
	C2-7515	Alzata 6 gradini				1	1	2	2	3	3	4	4	5	5	
	C5-7515	Palchetto 4 gradini			1	1	1	1	1	1	1	1	1	1	1	
	C4-7515	Palchetto 6 gradini			1	1	1	1	1	1	1	1	1	1	1	
C6-7515	Piano senza fermap.		1	1			1	1	1	1	1	1	2	2	2	
C7-7515	Piano con fermap.				1	1	1	1	1	1	1	1	1	1	1	
C84-7515	n. 4 stabilizzatori						1	1	1	1	1	1	1	1	1	
C134-7515	n. 4 protez. orizz.							1	1	1	1	1	2	2	2	
STANDARD	C1-BST	Base standard		1	1	1	1	1	1	1	1	1	1	1	1	
		codice	C30-1/C-BST	C31-1/C-BST	C32-1/C-BST	C33-1/C-BST	C34-1/C-BST	C35-1/C-BST	C36-1/C-BST	C37-1/C-BST	C38-1/C-BST	C39-1/C-BST	C40-1/C-BST	C41-1/C-BST	C42-1/C-BST	
		kg	43	58,7	68	80	103	141	144	156	159	171	196,5	208	213	
		m³	0,30	0,43	0,48	0,60	1,44	1,75	1,80	1,91	1,96	2,06	2,31	2,47	2,51	
PIEGHEVOLE	C1-BPI	Base pieghevole		1	1	1	1	1	1	1	1	1	1	1	1	
		codice	C30-1/C-BPI	C31-1/C-BPI	C32-1/C-BPI	C33-1/C-BPI	C34-1/C-BPI	C35-1/C-BPI	C36-1/C-BPI	C37-1/C-BPI	C38-1/C-BPI	C39-1/C-BPI	C40-1/C-BPI	C41-1/C-BPI	C42-1/C-BPI	
		kg	45	60,6	70	82	109,2	143,4	146,6	158,6	172	182	199	211	215	
		m³	0,45	0,58	0,63	0,75	1,59	1,91	1,94	2,06	2,10	2,07	2,45	2,57	2,61	
LIVELLANTE	C1-BLI	Base livellante		1	1	1	1	1	1	1	1	1	1	1	1	
		codice	C30-1/C-BLI	C31-1/C-BLI	C32-1/C-BLI	C33-1/C-BLI	C34-1/C-BLI	C35-1/C-BLI	C36-1/C-BLI	C37-1/C-BLI	C38-1/C-BLI	C39-1/C-BLI	C40-1/C-BLI	C41-1/C-BLI	C42-1/C-BLI	
		kg	46,6	62,2	77,5	89,5	112,5	150	153	165	168	180	205	217	222	
		m³	0,30	0,55	0,48	0,60	1,44	1,75	1,80	1,91	1,96	2,06	2,21	2,47	2,51	
Colli composizioni				2	3	4	5	6	9	9	10	10	11	13	14	14